

# CSTCR6M00G55-R0

目前生产 RoHS REACH

## 外观 & 形状

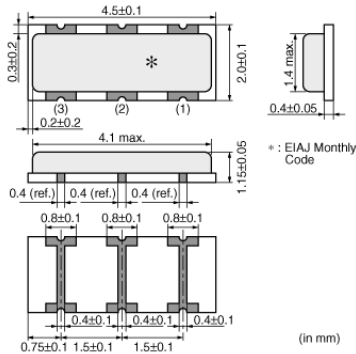

## 特点

MURATA's package technology expertise has enabled the development of the Chip "CERALOCK" with built-in load capacitors. High-density mounting can be realized because of the small package and the elimination of the need for an external load capacitor.

### Features

1. Oscillation circuits do not require external load capacitors.
2. The series is available in a wide frequency range.
3. The resonators are extremely small and have a low profile.
4. No adjustment is necessary for oscillation circuits.

## 用途

其他用途	消费级/工业级
------	---------

## 包装信息

包装	规格	最小订购单位
-R0	180mm压纹带	3000

# CSTCR6M00G55-R0

## 规格

形状	SMD
频率	6.000MHz
频率公差	±0.5%
工作温度范围	-20°C to 80°C
频率温度特性	±0.2%
频率老化	±0.1%
清洗	Not available
谐振阻抗	50Ω
内置负载电容	39pF